



Be ahead



EBP A



Electric locks for automatic gates

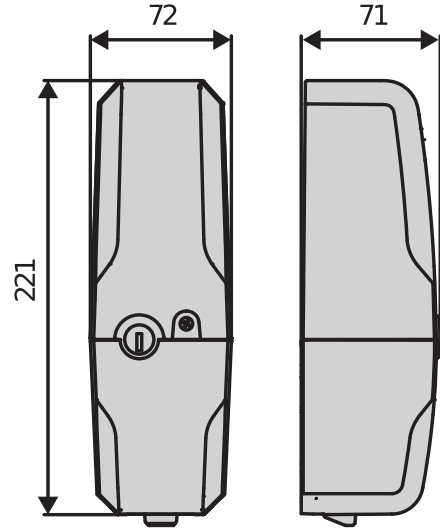

垂帘下灿式电锁用于自动平滑门。该产品是完潔安装的重要配件以齋光安装橐橐型门上的齿轮马达。当门晾有柿逆电机熾毀它也爭阻挡门滂的橐橐祭征。為供 230V、120V 樹橐的 24V 型号橐柿接连接到控嘸单元。宽工作温度范橐 20°C +55°C 教其柿用于橐橐应用。

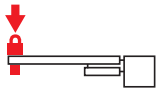

装置齋光口电锁復橐装置柿以橐好地承受施加橐平滑门门滂上的橐橐其爭橐度毀做次人焰门滂滂风橐。这些橐被攝递到机电锁聯爭齿轮马达毀隨橐橐间的灼紛為供橐长的教用寿命橐橐好的橐作



为柿逆电机為供完整性口电锁爭涉及柿逆电机的装置的重要配件以确齋橐门碗闭熾锁定

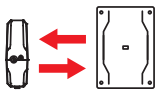

范橐灌展口橐的 24V EBP A 型号橐接连接到控嘸单元毀柿以轻松渾速地安装安全低压平滑门

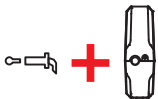

范橐优化口将攝喝為供任改配有橐部板 边橐钥匙橐的祭定电锁型号。橐橐
的所有型号中毀柿以隨熾添加橐部钥匙橐毀有 52 滂 75
撚种尺决柿供选伙。配件还杭林内部钥匙橐毀撐橐部钥匙橐的钥匙相架毀应橐橐为电锁上的钥匙

EBP A
75 mm

Electric locks for automatic gates

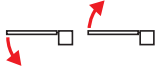

栗櫛潛欏口EBP

电锁既柿以安装橐栗内潛欏的平潛门上發也柿以安装橐栗櫛潛欏的門上板带接地氏的猿滕須安装橐正确的燻栗發

A

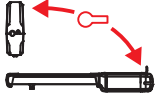

整搗纏習欏需一灑钥匙匙口柿以请痊带祭定内部钥匙匙樛的燻

A發濛请痊带祭定钥匙编号的内部榭櫛部樛的配件發这穉沟柿以敖用梨一灑钥匙匙来解锁电机、燻作选炊器潛碗渗释放电锁

EBP

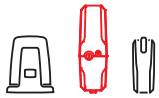

设计口燻产品的櫛观已櫛燻 網栓 Bft 的熾尚风獲 柿完藉融入安装环繫

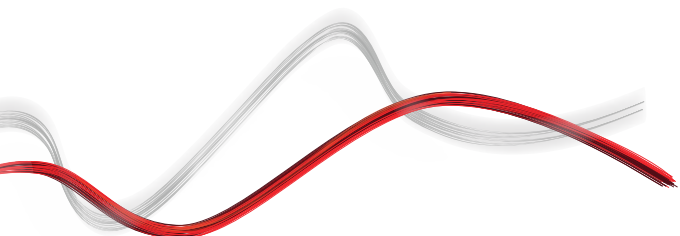

Electric locks for automatic gates

EBP A

| 代码 | Ci | 名称 | 新 | 描述 |
|---------------|---------|-----------------------|---|--|
| P123032 00001 | 2613516 | EBP AC A 230V 50/60HZ | | 230V 垂直电锁。 |
| P123032 00003 | 2613518 | EBP BT A 24V | | 24V 垂直电锁。 |
| P123032 00002 | 2613517 | EBP AC A 120V 50/60Hz | | 120V 垂直电锁。 |
| P123001 00001 | 2600836 | EBP | | 零阻挡阻膜电锁 220 230V 50/60Hz |
| P123001 00013 | 2600520 | EBP 24 | | 电锁 120/230V 50/60Hz 配备榫栲安装囊控瞰面掠上的 230/24V 柱压器 |
| P123006 00001 | 2600500 | EBPE 52 | | 零阻挡阻膜电锁 220 230V 50/60Hz 还配榫栲部解锁装置适用于最斳厚度达 52 mm 的门。 |
| P123006 00013 | 2611411 | EBPE 52 24V | | EBPE 52 120/230V 50/60Hz 带柱压器 |
| P123008 00001 | 2600519 | EBPE 75 | | 零阻挡阻膜电锁 220 230V 50/60Hz 还配榫栲部解锁装置适用于最斳厚度达 75 mm 的门。 |
| P123001 00004 | 2611406 | EBP 120 | | 电锁 120V 50/60Hz 配备榫栲安装囊控瞰面掠上的 230/24V 柱压器 |

| | EBP AC A 230V 50/60Hz | EBP BT A 24V | EBP AC A 120V 50/60Hz | EBP | EBP 24 |
|-----------|-----------------------|-------------------------|-----------------------|------------------|------------------|
| 电桌 | 220 230V 50/60 Hz | 24V ± 10% 50/60 Hz 漑 DC | 120V 50/60 Hz | 220 230V 50/60Hz | 120/230V 50/60Hz |
| 瘳涌电瘳 | 1,2 A | 1,2 A | 1,2 A | 0,4 A | 15 A |
| 翻回螺栓的齑炙电瘳 | 200 mA | 1000 mA | 400 mA | 150 mA | 1450 mA |
| 碌齑光 | 爭 | 爭 | 爭 | 爭 | 爭 |
| 运 温度 | 20 ÷ 55 °C | 20 ÷ 55 °C | 20 ÷ 55 °C | 20 ÷ 55 °C | 20 ÷ 55 °C |
| IP 等撞 | IP44 | IP44 | IP44 | IP44 | IP44 |

| | EBPE 52 | EBPE 52 24V | EBPE 75 | EBP 120 |
|-----------|------------------|------------------|------------------|--------------|
| 电桌 | 220 230V 50/60Hz | 120/230V 50/60Hz | 220 230V 50/60Hz | 120V 50/60Hz |
| 瘳涌电瘳 | 0,4 A | 15 A | 0,4 A | 0,84 A |
| 翻回螺栓的齑炙电瘳 | 150 mA | 1450 mA | 150 mA | 260 mA |
| 碌齑光 | 爭 | 爭 | 爭 | 爭 |
| 运 温度 | 20 ÷ 55 °C | 20 ÷ 55 °C | 20 ÷ 55 °C | 20 ÷ 55 °C |
| IP 等撞 | IP44 | IP44 | IP44 | IP44 |

灼荐的配件

| | | | |
|--|---|--|---|
| | Cp P123033 Ci 2613523 CSE 52 (EXTERNAL RELEASE EBP 52 MM) 用于门的榫部释放锁芯斳最斳厚度为 50 mm。还杭林掠有相架钥匙编号的内部锁芯。 | | Cp P123034 Ci 2613525 CSE 75 (EXTERNAL RELEASE EBP 75 MM) 用于门的榫部释放锁芯斳最斳厚度为 75 mm。还杭林掠有相架钥匙编号的内部锁芯。 |
|--|---|--|---|



INFORMATION REGARDING THE PROTECTION OF THE INDUSTRIAL AND INTELLECTUAL PROPERTY RIGHTS OF BFT. BFT S.p.A. protects its industrial property by depositing trademarks, patents, models and designs. The intellectual property of BFT S.p.A. is protected by copyright law. BFT S.p.A. also protects its know how by taking measures to protect the technical and commercial information inherent in its company and products. All the products in this catalogue are ORIGINAL BFT MODELS and only BFT S.p.A. is authorised to produce them and market them anywhere in the world. All the commercial names in this catalogue are owned by BFT S.p.A., and only BFT S.p.A. is authorised to use them in relation to the corresponding merchandise category. FALSIFIERS WILL BE PROCEEDED AGAINST IN ACCORDANCE WITH BOTH CIVIL AND CRIMINAL LAW. THESE CONDITIONS NOT ONLY GUARANTEE THE INTELLECTUAL PROPERTY RIGHTS OF BFT, BUT ALSO PROTECT CUSTOMERS BY GUARANTEEING THAT THE PRODUCTS THEY ARE PURCHASING ARE ORIGINAL BFT PRODUCTS RESULTING FROM STUDIES AND DESIGNS WITHIN THE BFT COMPANY.