

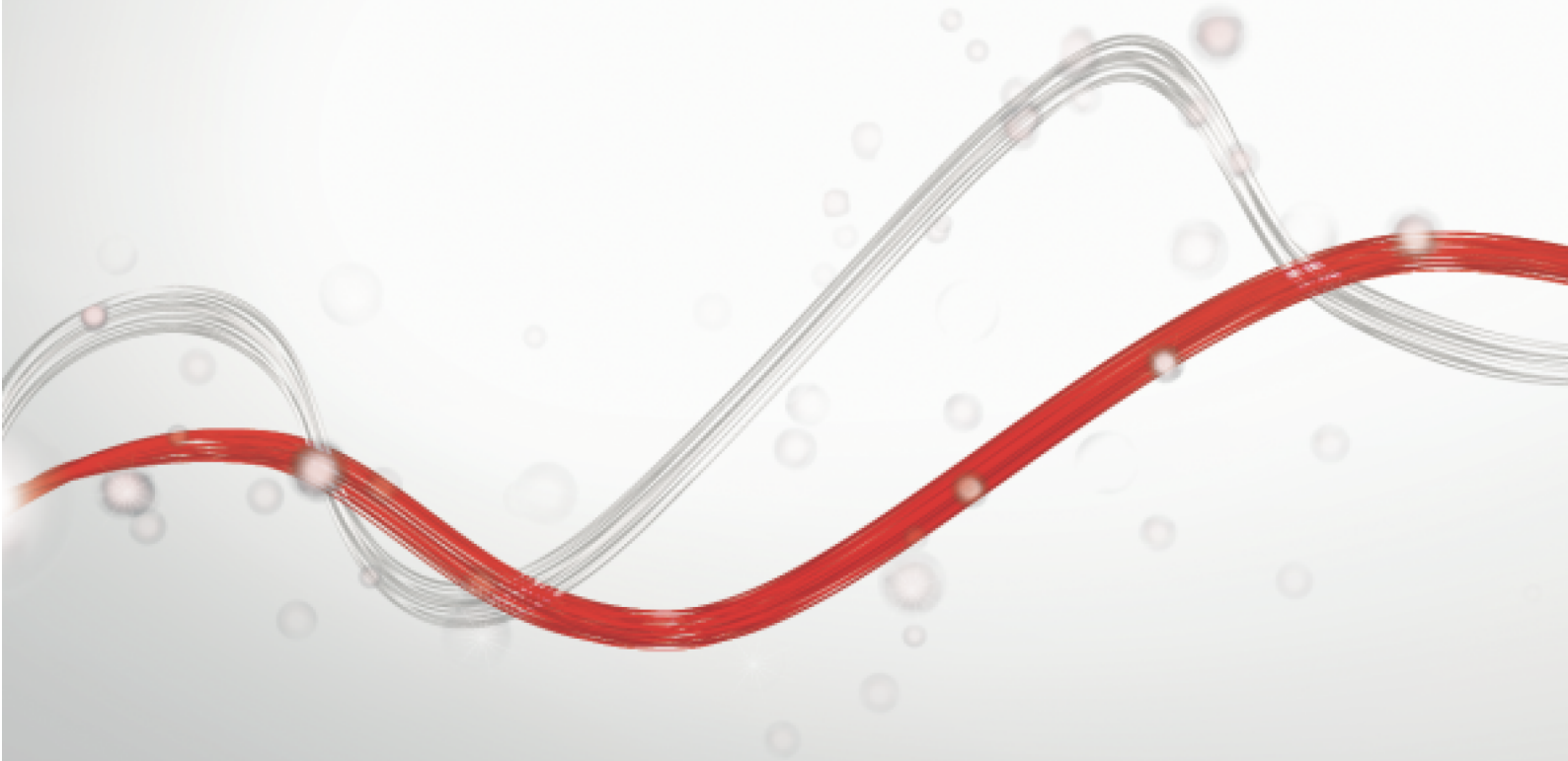

Be ahead

# GIOTTO BT B ULTRA 36





# GIOTTO BT B ULTRA 36

## Road barriers

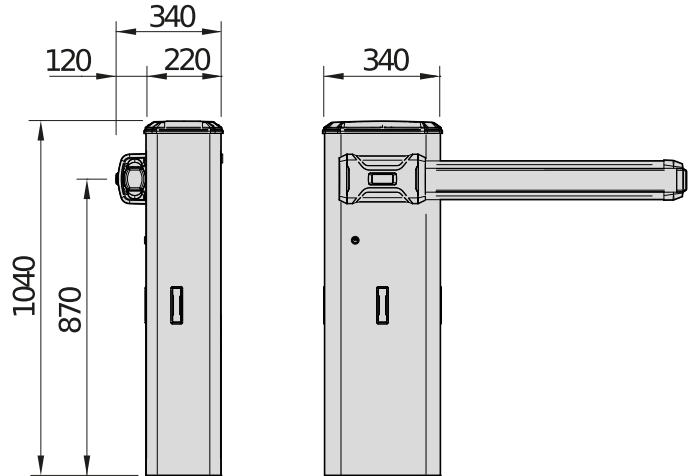

Visoki stupanj upravljanja pokretom i otpornost na udarce putem enkodera.  
Integrirana upravljačka jedinica s povezivosti U-Link.

Široki raspon dodataka za bilo koju vrstu primjene.



<b>Cp</b>	<b>Codice prodotto</b>	U-Link
<b>Ci</b>	<b>Codice internazionale</b>	New
		Phase-out



# GIOTTO BT B ULTRA 36

## Road barriers

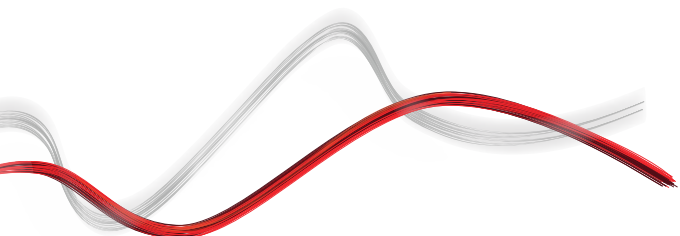
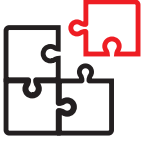

<b>Cp</b>	<b>Codice prodotto</b>		U-Link
<b>Ci</b>	<b>Codice internazionale</b>		New
			Phase-out



# GIOTTO BT B ULTRA 36

## Road barriers

### GIOTTO BT B ULTRA 36

Šifra	Ci	Naziv		Opis
P940111 00001	2617847	GIOTTO BT B ULTRA36 120V		Barrier with 24 V motor for opening from 2 to 6 metres and opening time from 2.2 to 4 s. 110-120V power supply. Balancing spring kit to be purchased separately. Reaction to impact via Encoder. Colour grey, RAL 7015. Integrated control unit with U-Link connectivity.
P940111 00101	2617848	GIOTTO BT B ULTRA36 120V RAL		Barrier with 24 V motor for opening from 2 to 6 metres and opening time from 2.2 to 4 s. 110-120V power supply. Balancing spring kit to be purchased separately. Reaction to impact via Encoder. Colour grey, special RAL. Integrated control unit with U-Link connectivity.
P940111 00002	2617937	GIOTTO BT B ULTRA36 230V		Barrier with 24 V motor for opening from 2 to 6 metres and opening time from 2.2 to 4 s. 220-230V power supply. Balancing spring kit to be purchased separately. Reaction to impact via Encoder. Colour grey, RAL 7015. Integrated control unit with U-Link connectivity.
P940111 00012	2617940	GIOTTO BT B ULTRA36 230V RAL		Barrier with 24 V motor for opening from 2 to 6 metres and opening time from 2.2 to 4 s. 220-230V power supply. Balancing spring kit to be purchased separately. Reaction to impact via Encoder. Colour grey, special RAL. Integrated control unit with U-Link connectivity.

#### MERAK GIOTTO ULTRA 36 230 V: Ugrađena upravljačka jedinica za rampu Giotto Ultra od 230 V

##### MERAK GIOTTO ULTRA 36 230 V - Cp I200486 10001 - Ci 2613697 - Ugrađeno -



- Napajanje ploče: 230 V jednofazno
- Glavne značajke: ugrađeni prijemnik, preokretanje pokreta po otkrivanju prepreka, upravljanje svjetlima i vanjskim priključkom U/I

#### MERAK GIOTTO ULTRA 36 120V: Ugrađena upravljačka jedinica za rampu Giotto Ultra od 120 V

##### MERAK GIOTTO ULTRA 36 120V - Cp I200487 10001 - Ci 2613698 - Ugrađeno -



- Napajanje ploče: 120V, jednofazno
- Glavne značajke: ugrađeni prijemnik, preokretanje pokreta po otkrivanju prepreka, upravljanje svjetlima i vanjskim priključkom U/I

	GIOTTO BT B ULTRA36 120V	GIOTTO BT B ULTRA36 120V RAL	GIOTTO BT B ULTRA36 230V	GIOTTO BT B ULTRA36 230V RAL
Vrijeme otvaranja (ovisno o širini šipke)	2,2 s	2,2 s	2,2 s	4 s
Korisni prolaz	4 m	4 m	4 m	6 m
Napajanje motora	24 V	24 V	24 V	24 V
Upravljačka jedinica	MERAK GIOTTO ULTRA 36	MERAK GIOTTO ULTRA 36	MERAK GIOTTO ULTRA 36	MERAK GIOTTO ULTRA 36
Usporavanje	Da	Da	Da	Da
Reakcija na udar	Enkoder	Enkoder	Enkoder	Enkoder
Otpuštanje u slučaju nužde	Personalizirani ključ	Personalizirani ključ	Personalizirani ključ	Personalizirani ključ
Broj otvaranja	vrlo intenzivan	vrlo intenzivan	vrlo intenzivan	intenzivan
Vanjski uvjeti	-20+55 °C	-20+55 °C	-20+55 °C	-20+55 °C
Stupanj zaštite	IP54	IP54	IP54	IP54

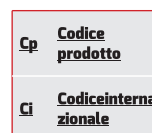



# GIOTTO BT B ULTRA 36

## Road barriers

	<b>Cp</b> P120104 00001 - <b>Ci</b> 2612607 <b>BOOM ES30</b> Aluminijska šipka za otvore široke 3 m. Gumene trake i svjetla nisu uključena.		<b>Cp</b> P120104 00002 - <b>Ci</b> 2612608 <b>BOOM ES40</b> Aluminijska šipka za otvore široke 4 m. Gumene trake i svjetla nisu uključena.
	<b>Cp</b> P120104 00003 - <b>Ci</b> 2612609 <b>BOOM ES50</b> Aluminijska šipka za otvore široke 5 m. Gumene trake i svjetla nisu uključena.		<b>Cp</b> P120104 00004 - <b>Ci</b> 2612610 <b>BOOM ES60</b> Aluminijska šipka za otvore široke 6 m. Gumene trake i svjetla nisu uključena.
	<b>Cp</b> P120117 00001 - <b>Ci</b> 2613384 <b>PCA ES N3</b> Komplet donje i gornje zaštitne gumene trake za šipke BOOM ES dužine 3 m. Zaključni čepovi i kopče za pričvršćivanje isporučenih svjetala.		<b>Cp</b> P120117 00002 - <b>Ci</b> 2613385 <b>PCA ES N4</b> Komplet donje i gornje zaštitne gumene trake za šipke BOOM ES dužine 4 m. Zaključni čepovi i kopče za pričvršćivanje isporučenih svjetala.
	<b>Cp</b> P120117 00003 - <b>Ci</b> 2613386 <b>PCA ES N5</b> Komplet donje i gornje zaštitne gumene trake za šipke BOOM ES dužine 5 m. Zaključni čepovi i kopče za pričvršćivanje isporučenih svjetala.		<b>new Cp</b> P120117 00004 - <b>Ci</b> 2617951 <b>PCA ES N6</b> Lower and upper protective rubber strip kit for 6 m BOOM ES. Blanking plugs and fastening clips for lights included.
	<b>Cp</b> P120103 - <b>Ci</b> 2612606 <b>OMEGA ES</b> Hvataljka za rampu, navlaka za zaštitu ruku i vijci za BOOM ES na uređaju Giotto Ultra 36. Rampa nije uključena.		<b>Cp</b> P120087 00001 - <b>Ci</b> 2601376 <b>BOOM PS30</b> Aluminijska šipka, otvor L = 3 m i crveni reflektori. Uključuje gumu i gornji optički difuzor. Svjetla nisu uključena.
	<b>Cp</b> P120087 00002 - <b>Ci</b> 2601377 <b>BOOM PS40</b> Aluminijska šipka, otvor L = 4 m i crveni reflektori. Uključuje gumu i gornji optički difuzor. Svjetla nisu uključena.		<b>Cp</b> P120087 00003 - <b>Ci</b> 2601378 <b>BOOM PS50</b> Aluminijska šipka, otvor L = 5 m uz crvene reflektore. Uključuje gumu i gornji optički difuzor. Svjetla nisu uključena.
	<b>Cp</b> P120087 00004 - <b>Ci</b> 2601277 <b>BOOM PS60</b> Aluminijska šipka, otvor L = 6 m uz crvene reflektore. Uključuje gumu i gornji optički difuzor. Svjetla nisu uključena.		<b>Cp</b> P120100 - <b>Ci</b> 2605247 <b>OMEGA PS GIOTTO ULTRA 36</b> Hvataljka za rampu, navlaka za zaštitu ruku i vijci za BOOM PS na uređaju Giotto Ultra 36. Rampa nije uključena.

## PREPORUČENA DODATNA OPREMA

	<b>new Cp</b> P120125 - <b>Ci</b> 2617945 <b>TOP LIGHT GU36</b> Light ring to be placed under the barrier cap. Includes red/green LED lights and fixing brackets. Barrier cap not included.		<b>new Cp</b> P120126 - <b>Ci</b> 2617949 <b>KIT ML65-L</b> Balancing spring kit for bar length up to 4 metres.
	<b>new Cp</b> P120127 - <b>Ci</b> 2617950 <b>KIT ML81-H</b> Balancing spring kit for bar length up to 6 metres.		<b>Cp</b> P120089 20001 - <b>Ci</b> 2605241 <b>LIGHT PS/ES 30-IP67</b> Komplet visokointenzivnih svjetala LED, boje crvene i zelene, koji se postavlja na šipku BOOM PS duljine do 3 metara. Jedinica za napajanje ne isporučuje se.
	<b>Cp</b> P120089 20002 - <b>Ci</b> 2605242 <b>LIGHT PS/ES 40-IP67</b> Komplet visokointenzivnih svjetala LED, boje crvene i zelene, koji se postavlja na šipku BOOM PS duljine do 4 metara. Jedinica za napajanje ne isporučuje se.		<b>Cp</b> P120089 20003 - <b>Ci</b> 2605243 <b>LIGHT PS/ES 50-IP67</b> Komplet visokointenzivnih svjetala LED, boje crvene i zelene, koji se postavlja na šipku BOOM PS duljine do 5 metara. Jedinica za napajanje ne isporučuje se.

<b>Cp</b>	<b>Codice prodotto</b>		U-Link
<b>Ci</b>	<b>Codice internazionale</b>	<b>new</b>	New
			Phase-out



# GIOTTO BT B ULTRA 36

## Road barriers

### PREPORUČENA DODATNA OPREMA

	<b>Cp</b> P120089 20004 - <b>Ci</b> 2605244 <b>LIGHT PS/ES 60-IP67</b> Komplet visokointenzivnih svjetala LED, boje crvene i zelene, koji se postavlja na šipku BOOM PS duljine do 6 metara. Jedinica za napajanje ne isporučuje se.		<b>Cp</b> P120116 - <b>Ci</b> 2601492 <b>GT BOARD</b> Jedinica za napajanje za svjetla LIGHT PS/ES za uređaj Giotto Ultra 36
	<b>Cp</b> P120122 - <b>Ci</b> 2614971 <b>ART90 PS GIOTTO ULTRA36 KIT</b> Hinge accessories kit for PS 90° articulated bar on Giotto Ultra 36. Excludes tie rod, bar, bar connector and PS lights. Compatible with PS BOOMS		<b>Cp</b> P120121 - <b>Ci</b> 2614918 <b>TIE ROD FOR ART90 PS KIT</b> Tie rod to be combined with the hinge accessories kit for PS 90° articulated bar. Compatible with ART 90 PS MAXIMA ULTRA KIT 36 and ART 90 GIOTTO ULTRA 36 KIT
	<b>Cp</b> P120092 00006 - <b>Ci</b> 2614231 <b>ART90 BOOM PS30 GIOTTO ULTRA36</b> BOOM PS 90° articulated bar L = 3 m pre-assembled. Excludes LIGHT PS lighting. Compatible with Giotto Ultra 36.		<b>Cp</b> P120092 00007 - <b>Ci</b> 2614227 <b>ART90 BOOM PS50 GIOTTO ULTRA36</b> BOOM PS 90° articulated bar L = 5 m pre-assembled. Excludes LIGHT PS lighting. Compatible with Giotto Ultra 36.
	<b>Cp</b> P120085 - <b>Ci</b> 2601279 <b>BTM-SKIRT</b> Donja ograda za šipke BOOM PS. Dužina modula L = 2 m.		<b>Cp</b> P120095 - <b>Ci</b> 2601389 <b>BRACKET SKIRT</b> Spojni nosač između tijela rampe i jednostavnog (BTM SKIRT) ili dvostrukog (FULL SKIRT) aluminijskog stalka.
	<b>Cp</b> P120093 - <b>Ci</b> 2613063 <b>ADJ-FOOT</b> Viseće amortizirano teleskopsko podnožje za šipke BOOM PS.		<b>Cp</b> P120074 - <b>Ci</b> 2607202 <b>GIOTTO M BG BAT KIT</b> Komplet rezervnog baterijskog napajanje za rampe serije Giotto BT A
	<b>Cp</b> P111782 - <b>Ci</b> 2601411 <b>COMPACTA A20-180</b> Par fotočelija koje se mogu vodoravno namjestiti za 180°. Raspon od 20 m. Napajanje 12 – 33 V istosmjerna (AC) / 15 – 35 V izmjenična struja (DC)		<b>Cp</b> P111274 - <b>Ci</b> 2611230 <b>RME 1 BT</b> Jednokanalni detektor za metalne mase 24 V s instalacijskom osnovom
	<b>Cp</b> P903031 - <b>Ci</b> 2605301 <b>BMC A</b> Potpora za postavljanje fotočelija serije COMPACTA na zid i na rampe Giotto, Moovi i Michelangelo		<b>Ph Out</b> <b>Cp</b> D730251 - <b>Ci</b> 2608500 <b>CBO</b> Postolje za rampu MOOVI - GIOTTO
	<b>new</b> <b>Cp</b> P120128 - <b>Ci</b> 2617952 <b>CBO PRO</b> Foundation template and clamps for installation of Giotto Ultra 36 barriers/Moovi AC.		<b>Cp</b> P120080 - <b>Ci</b> 2601319 <b>FAF UNI R</b> Univerzalna vilica za sve letve; preporučuje se uz postavljanje dodatka FULL SKIRT.
	<b>Cp</b> P111786 - <b>Ci</b> 2605171 <b>LOOP DETECTOR PRO 230V</b> Detektor metalnih predmeta, 2 kanala, od 230 V AC, do 4 frekvencije po kanalu za ugrađivanje susjednih zavojnica, prilagodljiva razina osjetljivosti, funkcija pojačanja za povećanje osjetljivosti, upravljanje smjerom kretanja		<b>Cp</b> P111001 00003 - <b>Ci</b> 2611209 <b>RME 2</b> Jednokanalni detektor za metalne mase 230 V, s instalacijskom osnovom
	<b>Cp</b> P120023 - <b>Ci</b> 2600216 <b>FAF 2</b> Potporna vilica za letve. Pričvrstiti za tlo.		<b>Cp</b> P120023 00100 - <b>Ci</b> 2613115 <b>FAF 2 RAL</b> Vilice za fiksno pričvršćivanje letve obojene u personaliziranu RAL boju. Pričvrstiti za tlo.
	<b>Cp</b> P120026 - <b>Ci</b> 2605194 <b>ZFAF2</b> Dodatne vilice za cementiranje vilica model FAF2 za tlo.		<b>Cp</b> D110926 00001 - <b>Ci</b> 2600569 <b>SPIRA 2X1</b> Induktivna petlja 2 x 1 m

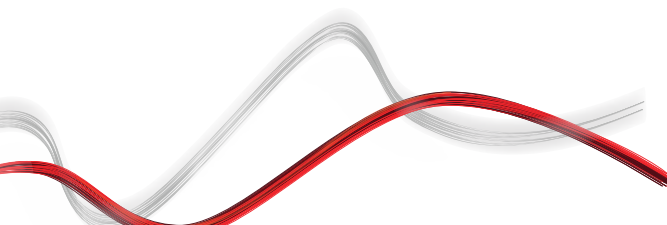

<b>Cp</b>	<b>Codice prodotto</b>		U-Link
<b>Ci</b>	<b>Codice internazionale</b>		New
			Phase-out



# GIOTTO BT B ULTRA 36

## Road barriers

### PREPORUČENA DODATNA OPREMA

	<b>new</b> <b>Cp</b> D112306 - <b>Ci</b> 2614118 <b>MITTO COOL C2</b> 2-Channel transmitter. 50/100 m range. 3V power supply with 1 CR2032 type battery. Blue.		<b>new</b> <b>Cp</b> D112318 - <b>Ci</b> 2614120 <b>MITTO COOL C4</b> 4-Channel transmitter. 50/100 m range. 3V power supply with 1 CR2032 type battery. Blue.
--	--	---	--

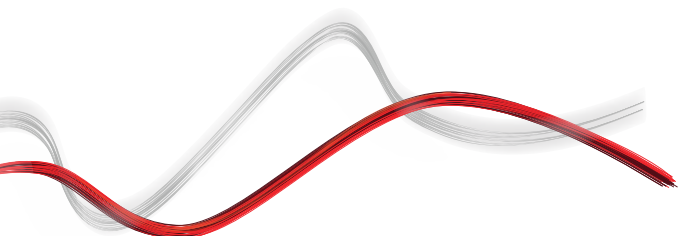

<b>Cp</b> <b>Codice prodotto</b>	 U-Link
<b>Ci</b> <b>Codice internazionale</b>	<b>new</b> New
	 Phase-out



## Road barriers

# Što je U-Link?

Tehnologija koja vam daje više snage

U-Link (Univerzalna poveznica) ekskluzivna je platforma poduzeća BFT koja se može upotrebljavati za stvaranje visokotehnoških ekosustava. U automatizaciji pristupa domu može se upotrebljavati za komuniciranje sa svim uređajima automatizacije pristupa domu bilo koje marke. Time štedite na vremenu te možete jednostavno i bezbrižno svim upravljati.

### Platforma je intuitivna

Jednostavno ju je ugraditi i rabiti

### Platforma je skalabilna

Možete dodati uređaja koliko god želite

### Platforma je prilagodljiva

Možete stvarati grupe međupovezanih proizvoda

### Platforma je praktična

Radi sa ili bez internetskog priključka

### Platforma je funkcionalna

Postavkama je moguće upravljati na daljinu upotrebom namjenskih aplikacija





## Road barriers

### Sve na jednom zaslonu: saznaj više o ovoj nevjerojatnoj tehnologiji

Platforma ekskluzivna u svijetu koja se **može upotrebljavati za stvaranje visokotehnoloških ekosustava** i kojom se pruža širok raspon rješenja za razna područja primjene.

Ova vlasnička platforma koja je ključna značajka proizvoda poduzeća BFT zbog kartica B-EBA i prijemnika Clonix U-Link prikladna je za svaki protokol ili proizvod za automatizaciju pristupa (uključujući proizvode poduzeća BFT, proizvode koji nisu od poduzeća BFT i proizvode starije generacije) i može se rabiti u širokom rasponu područja primjene. Time se podrazumijeva da bilo koji uređaj postaje pametni uređaj koji se može povezati s drugim sustavima upotrebom jezika koji postaje univerzalan.



#### U-Control HOME

U-Control HOME je aplikacija kojom se omogućuje otvaranje kućnih vrata i upravljanje na daljinu automatizacijama BFT Automation upotrebom pametnog telefona. Inačica za sustav iOS može se upotrijebiti za automatsko otvaranje automatizacije kada ste blizu nje.



#### U-Base 2

Softverski paket za instalaciju, provođenje održavanja i utvrđivanje kvarova operatora kompatibilnih s tehnologijom U-Link na jednostavan i praktičan način.



#### U-SDK

U-SDK je aplikacija kojom se omogućuje kompatibilnost i jednostavna integracija za automatizacije BFT Automation s mrežom BMS.



#### Clonix U-Link

Povežite neizvorne proizvode tehnologije U-Link i proizvode koji nisu od poduzeća BFT sa sustavima tehnologije U-Link.

Je li moguće povezati neizvorne operatore tehnologije U-Link poduzeća BFT ili druge marke proizvoda s tehnologijom U-Link? Da, zahvaljujući prijamnicima Clonix. Dodatci bez ograničenja.



#### B-EBA

Izravna poveznica s vašim operatorima.

Pločama B-EBA za proširenje omogućuje se povezivanje vanjskih uređaja kao što su osobna računala, pametni telefoni i tableti s operatorom poduzeća BFT i prijemnikom Clonix ili povezivanje nekoliko proizvoda poduzeća BFT u mreži tehnologije U-Link. Ti dodatci integriraju se s tehnologijom U-Link, protokolima Bluetooth, Z-Wave i TCP/IP te serijskim sučeljem RS485. Uređaj kojim se demonstrira točno što poduzeće BFT podrazumijeva pod međupovezanosti.

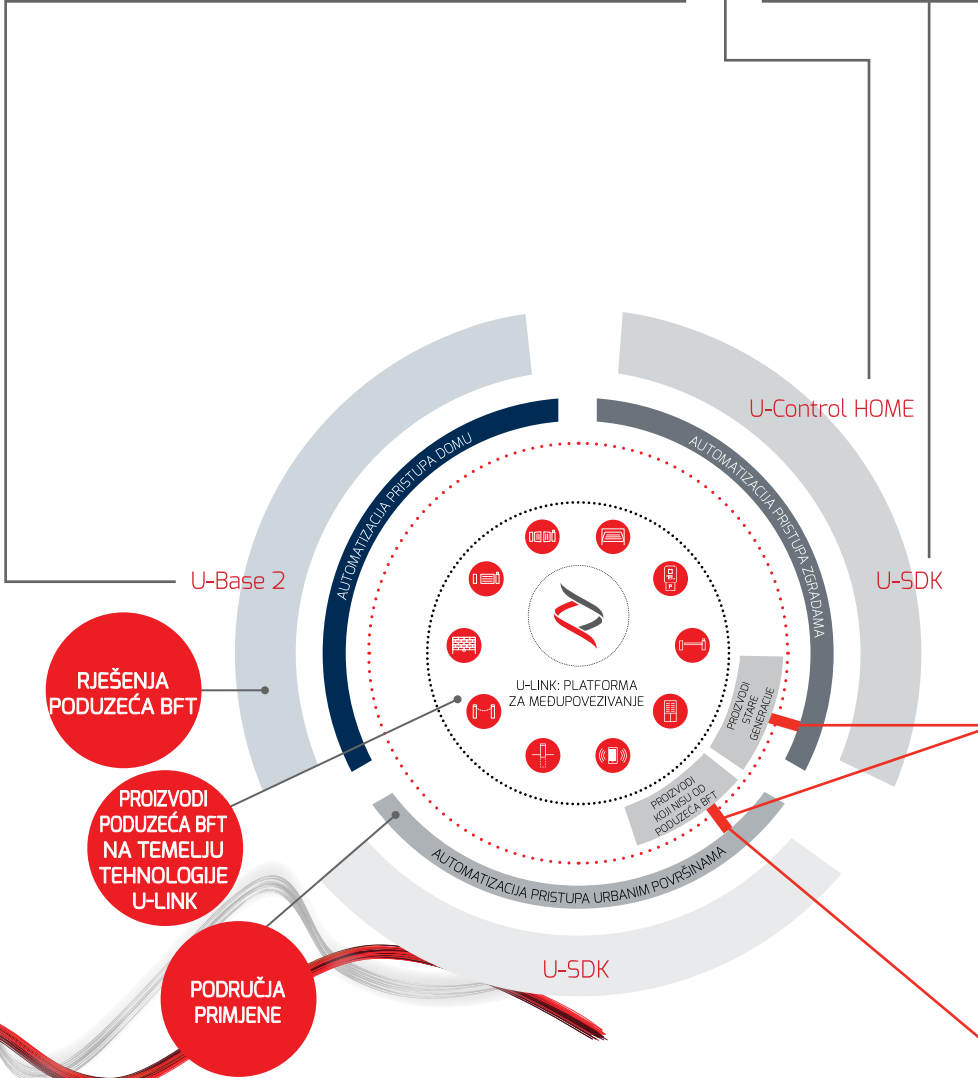



INFORMATION REGARDING THE PROTECTION OF THE INDUSTRIAL AND INTELLECTUAL PROPERTY RIGHTS OF BFT. BFT S.p.A. protects its industrial property by depositing trademarks, patents, models and designs. The intellectual property of BFT S.p.A. is protected by copyright law. BFT S.p.A. also protects its know-how by taking measures to protect the technical and commercial information inherent in its company and products. All the products in this catalogue are ORIGINAL BFT MODELS and only BFT S.p.A. is authorised to produce them and market them anywhere in the world. All the commercial names in this catalogue are owned by BFT S.p.A., and only BFT S.p.A. is authorised to use them in relation to the corresponding merchandise category. FALSIFIERS WILL BE PROCEEDED AGAINST IN ACCORDANCE WITH BOTH CIVIL AND CRIMINAL LAW. THESE CONDITIONS NOT ONLY GUARANTEE THE INTELLECTUAL PROPERTY RIGHTS OF BFT, BUT ALSO PROTECT CUSTOMERS BY GUARANTEEING THAT THE PRODUCTS THEY ARE PURCHASING ARE ORIGINAL BFT PRODUCTS RESULTING FROM STUDIES AND DESIGNS WITHIN THE BFT COMPANY.